



JSC [HPC] SYSTEMS

JUWELS, JURECA-DC and JUSUF

16.05.2022 | D. ALVAREZ

JSC [HPC] SYSTEMS

- JSC is a multi-system facility



JSC [HPC] SYSTEMS

- JSC is a multi-system facility
- Main HPC systems are:
 - JUWELS
 - JURECA-DC
 - JUSUF
- Shared storage!
- Different talk

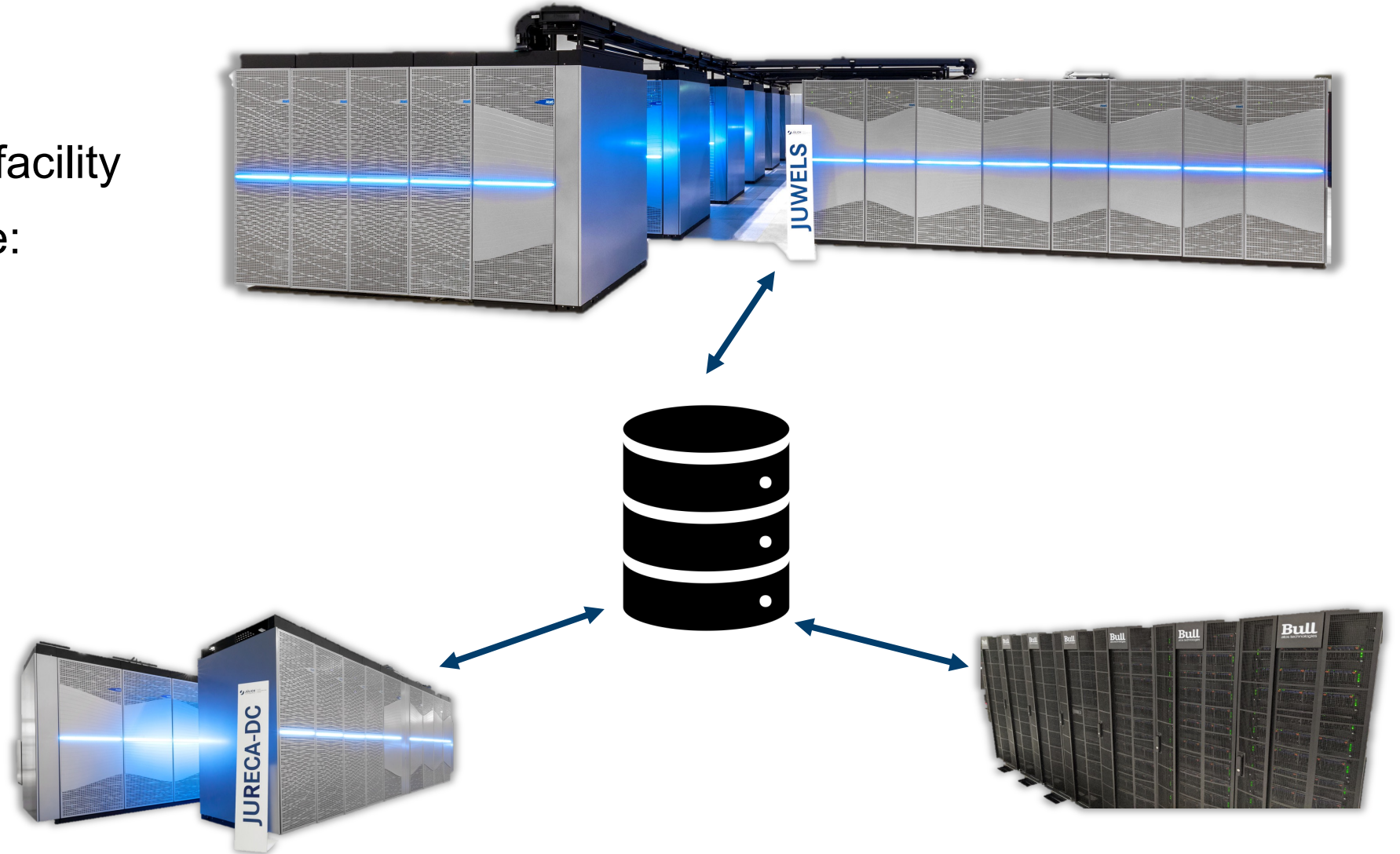

BRIEF JUWELS TIMELINE



BRIEF JUWELS TIMELINE

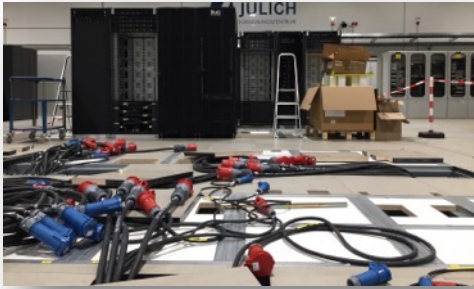

JUWELS Cluster
installation begins



BRIEF JUWELS TIMELINE

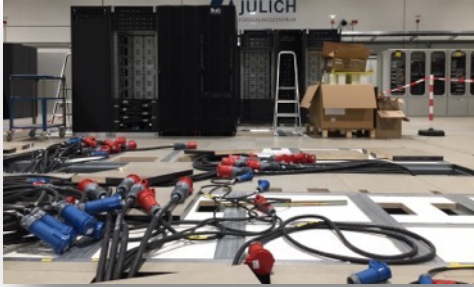

JUWELS Cluster
installation begins

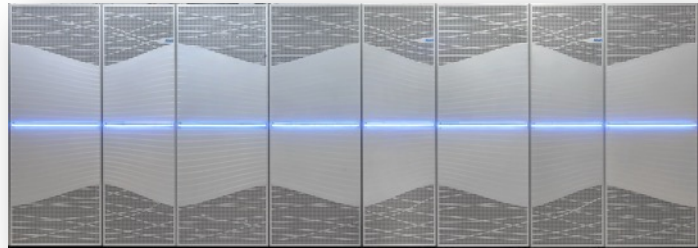

BRIEF JUWELS



CERTIFICATE

JUWELS Module 1 - Bull Sequana X1000, Xeon Platinum 8168 24C 2.7GHz,
Mellanox EDR InfiniBand/ParTec ParaStation ClusterSuite
Forschungszentrum Juelich (FZJ), Germany

is ranked

No. 77

among the World's TOP500 Supercomputers
with **6.18 PFlop/s Linpack Performance**
in the 58th TOP500 List published at the SC21

Conference on November 16, 2021.

Congratulations from the TOP500 Editors

Erich Strohmaier
NERSC/Berkeley Lab

Jack Dongarra
University of Tennessee

Horst Simon
NERSC/Berkeley Lab

Martin Meuer
Prometeus



CERTIFICATE

JUWELS Module 1 - Bull Sequana X1000, Xeon Platinum 8168 24C 2.7GHz,
Mellanox EDR InfiniBand/ParTec ParaStation ClusterSuite
Forschungszentrum Juelich (FZJ), Germany

is ranked

No. 76

among the World's TOP500 Supercomputers
with **4.539 GFlops/watts Performance**
in the Green500 List published at the SC21

Conference on November 16, 2021.

Congratulations from the Green500 Editors

Wu-chun Feng
Virginia Tech

Kirk Cameron
Virginia Tech

JUWELS CLUSTER NODES





- 2511 compute nodes **Atos**
 - 2x 24-core Intel Xeon Platinum 8168 **intel**
 - 2x 6 memory channels
 - 2x 48 GB DDR4 @ 2.666 GHz
 - 240 nodes with 2x 96 GB DDR4 @ 2.666 GHz
 - PCIe Gen3
 - 1x EDR InfiniBand adapter (100Gbps) 

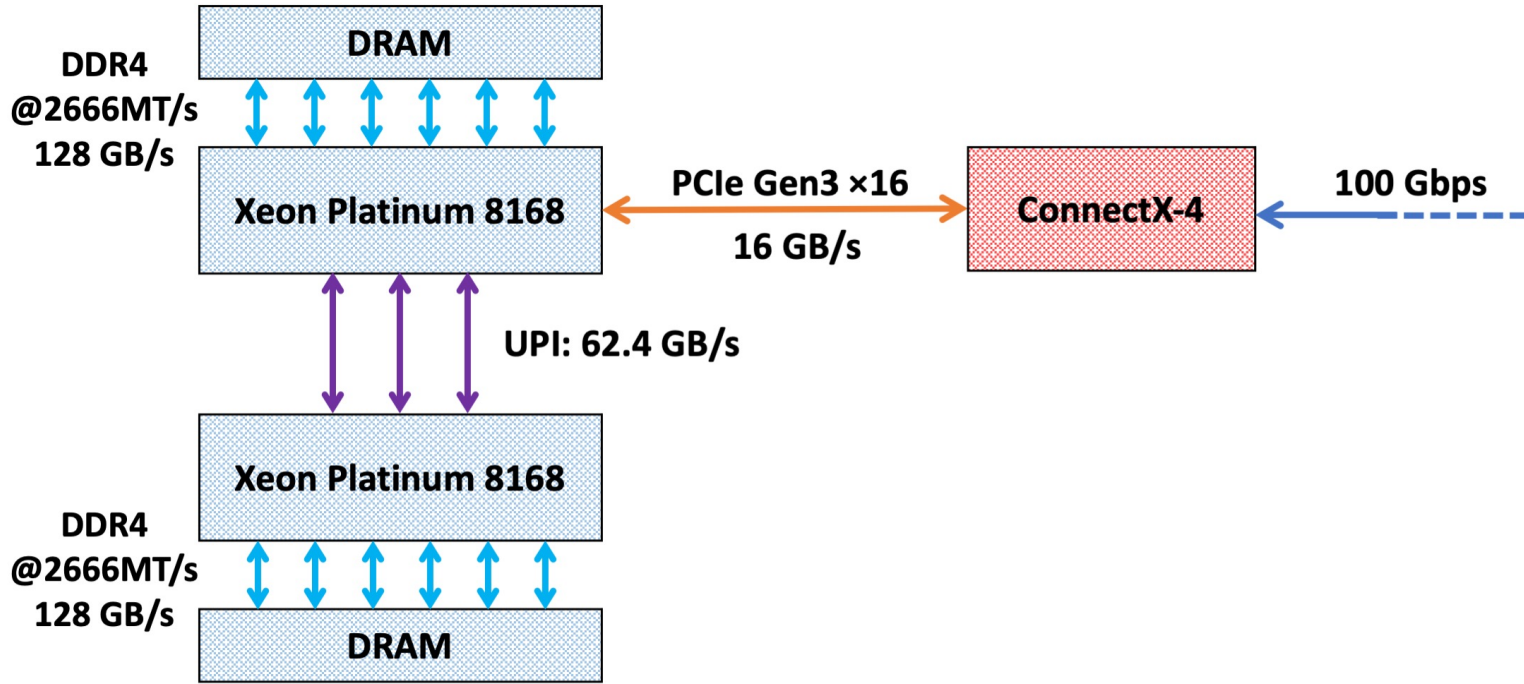

JUWELS CLUSTER NODES



JUWELS CLUSTER GPU NODES

- 56 compute nodes 
 - 2x 20-core Intel Xeon Gold 6148 
 - 2x 6 memory channels
 - 2x 96 GB DDR4 @ 2.666 GHz
 - PCIe Gen3
 - PCIe Switch
 - 4x Nvidia V100 GPUs 
 - 7.8 TF/s peak
 - 16 GB HBM2
 - 900 GB/s memory performance
 - NVLink2 full mesh
 - 2 links (100GB/s bidir) between GPU pairs
 - PCIe Gen3 x16 (32 GB/s bidir)
 - 2x EDR InfiniBand adapter (100 Gbps) 



JUWELS CLUSTER GPU NODES

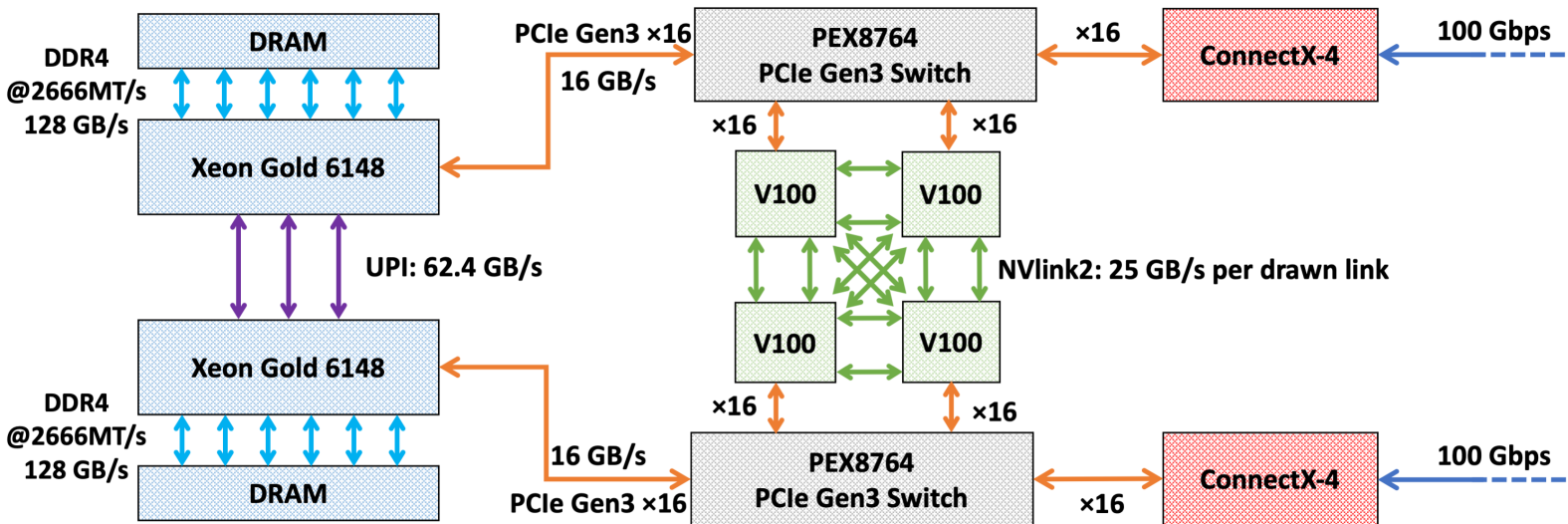

BRIEF JUWELS TIMELINE

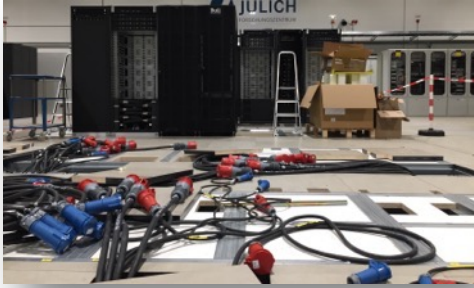

JUWELS Cluster
installation begins

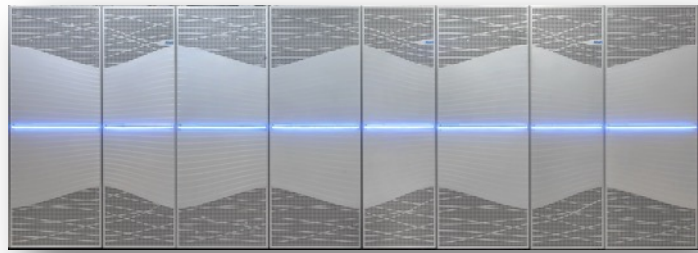
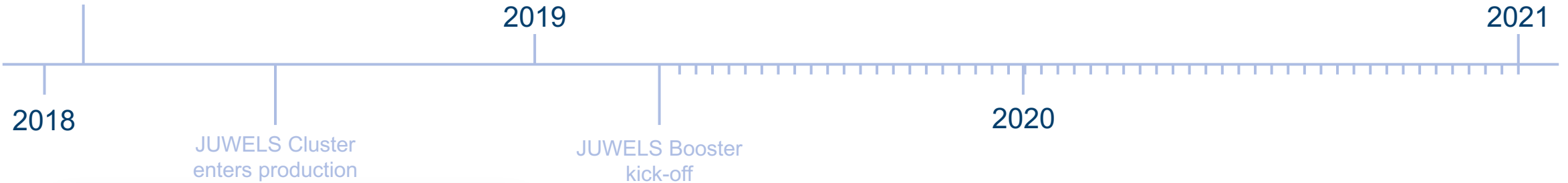

BRIEF JUWELS TIMELINE

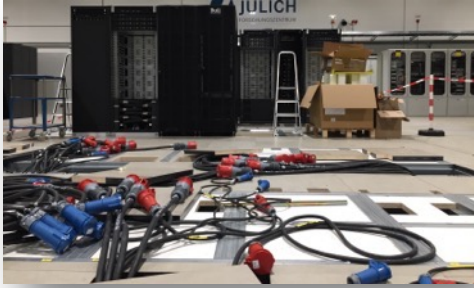

JUWELS Cluster installation begins

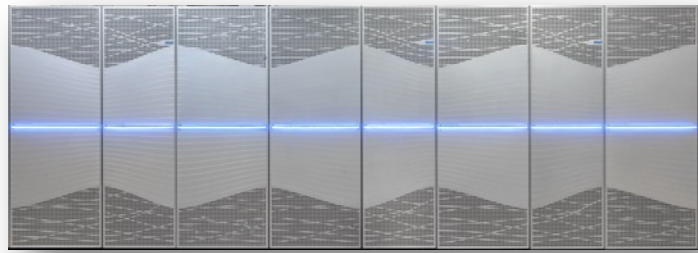
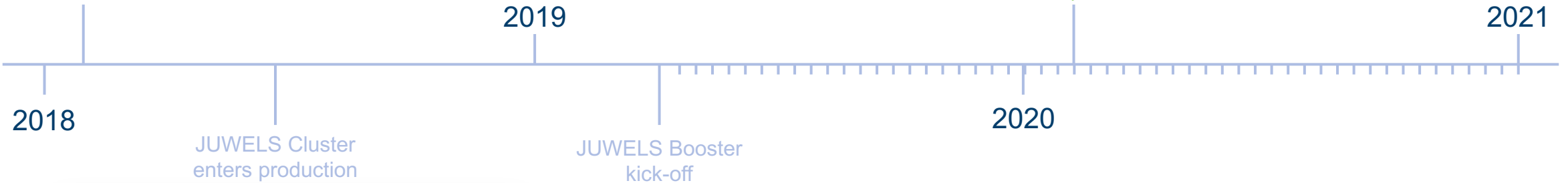

BRIEF JUWELS TIMELINE



JUWELS Cluster
installation begins

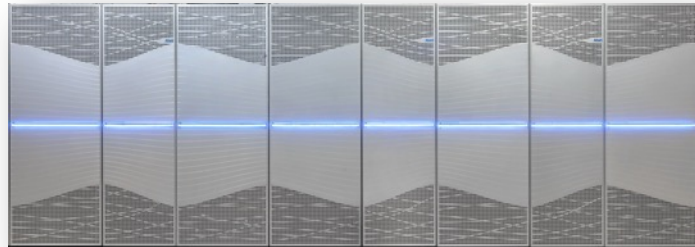
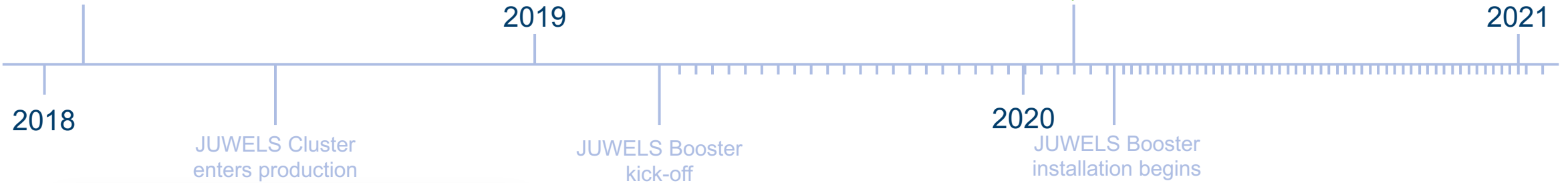

BRIEF JUWELS TIMELINE

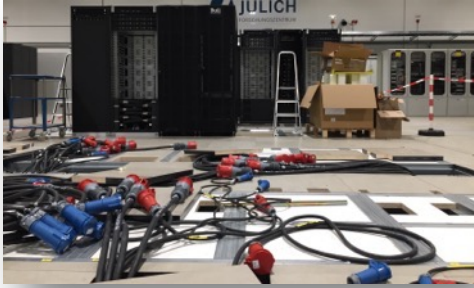

JUWELS Cluster
installation begins

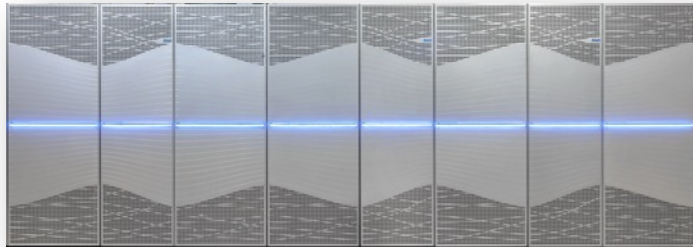

BRIEF JUWELS TIMELINE

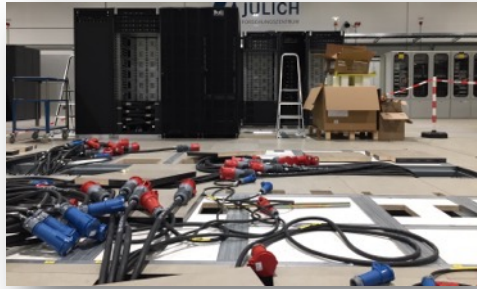

JUWELS Cluster installation begins



JUWELS Booster enters production

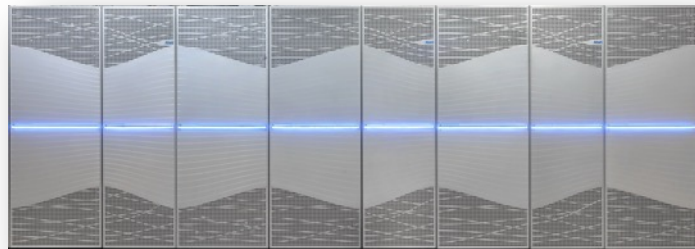
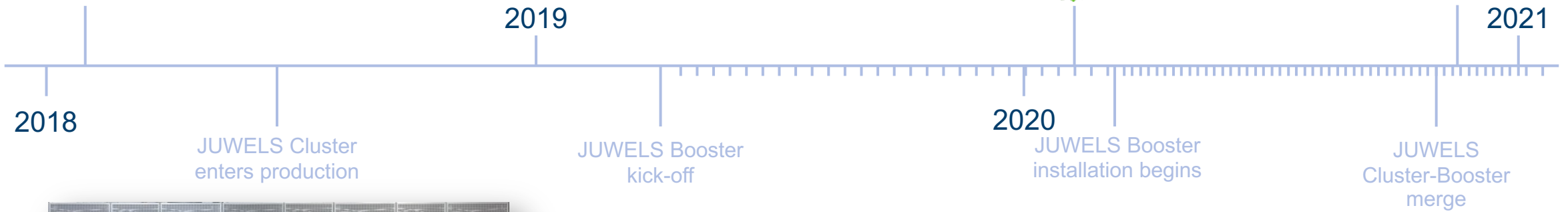

BRIEF JUWELS TIME



TOP 500 CERTIFICATE

The List.

JUWELS Booster Module - Bull Sequana XH2000 , AMD EPYC 7402 24C 2.8GHz, NVIDIA A100,
Mellanox HDR InfiniBand/ParTec ParaStation ClusterSuite
Forschungszentrum Juelich (FZJ), Germany

is ranked

No. 8

among the World's TOP500 Supercomputers
with **44.12 PFlop/s Linpack Performance**
in the 58th TOP500 List published at the SC21
Conference on November 16, 2021.

Congratulations from the TOP500 Editors

Jack Dongarra
University of Tennessee

Horst Simon
NERSC/Berkeley Lab

Martin Meuer
Prometeus

The **GREEN 500** CERTIFICATE

JUWELS Booster Module - Bull Sequana XH2000 , AMD EPYC 7402 24C 2.8GHz, NVIDIA A100,
Mellanox HDR InfiniBand/ParTec ParaStation ClusterSuite
Forschungszentrum Juelich (FZJ), Germany

is ranked

No. 11



among the World's TOP500 Supercomputers
with **25.008 GFlops/watts Performance**
in the Green500 List published at the SC21
Conference on November 16, 2021.

Congratulations from the Green500 Editors

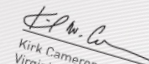
Wu-chun Feng
Virginia Tech

Kirk Cameron
Virginia Tech

JUWELS BOOSTER NODES

- 936 compute nodes **Atos**
 - 2x 24-core AMD Epyc 7402 Rome CPUs **AMD**
 - 2x 8 memory channels
 - 2x 256 GB DDR4 @ 3.2GHz
 - 2x 4 NUMA domains
 - 96 PCIe Gen4 lanes
 - 512 GB DDR memory
 - **4x** Nvidia **A100** GPUs 
 - 9.7 / 19.5 TF/s peak
 - 40 GB HBM2
 - 1.5 TB/s memory performance
 - NVLink3 full mesh
 - 4 links (200GB/s) between GPU pairs
 - PCIe Gen4 x32 (64 GB/s)
 - **4x HDR200** InfiniBand adapter (1 per GPU) 

Member of the Helmholtz Association



JUWELS BOOSTER NODES

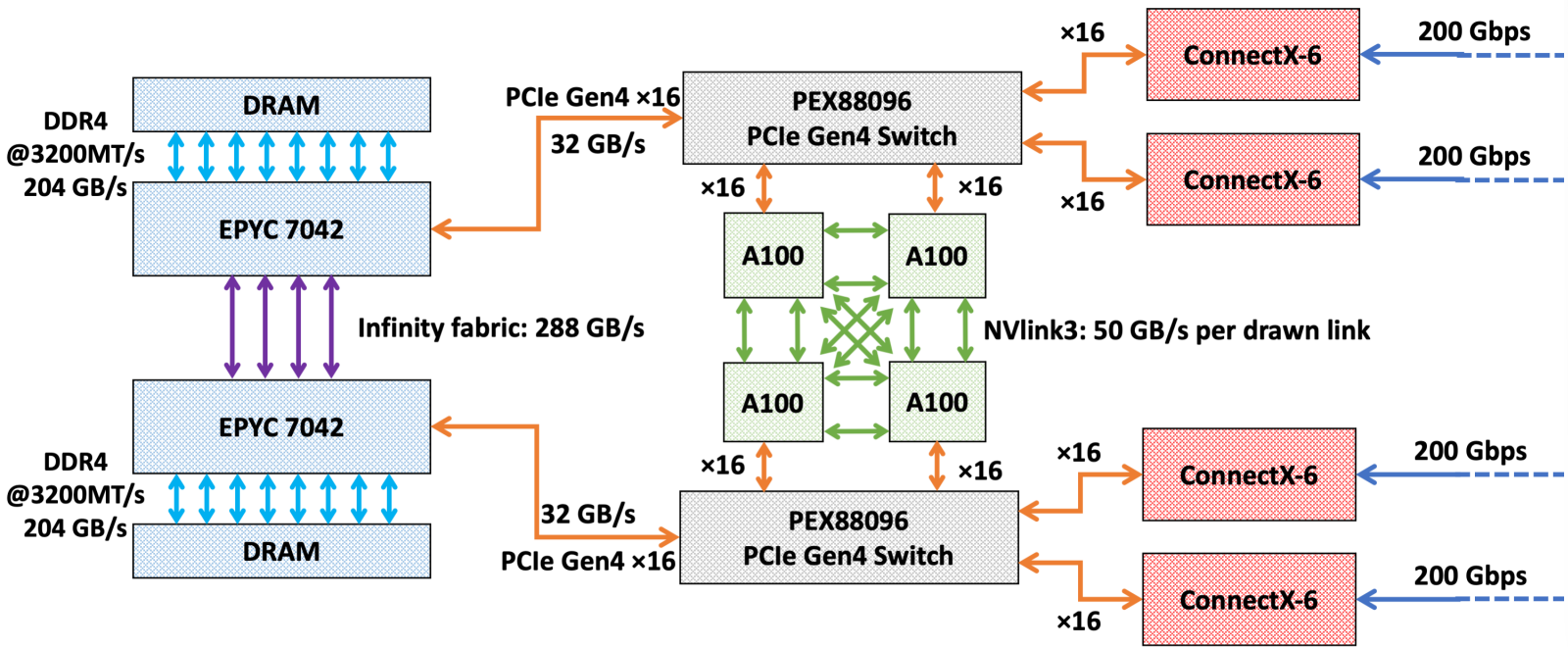

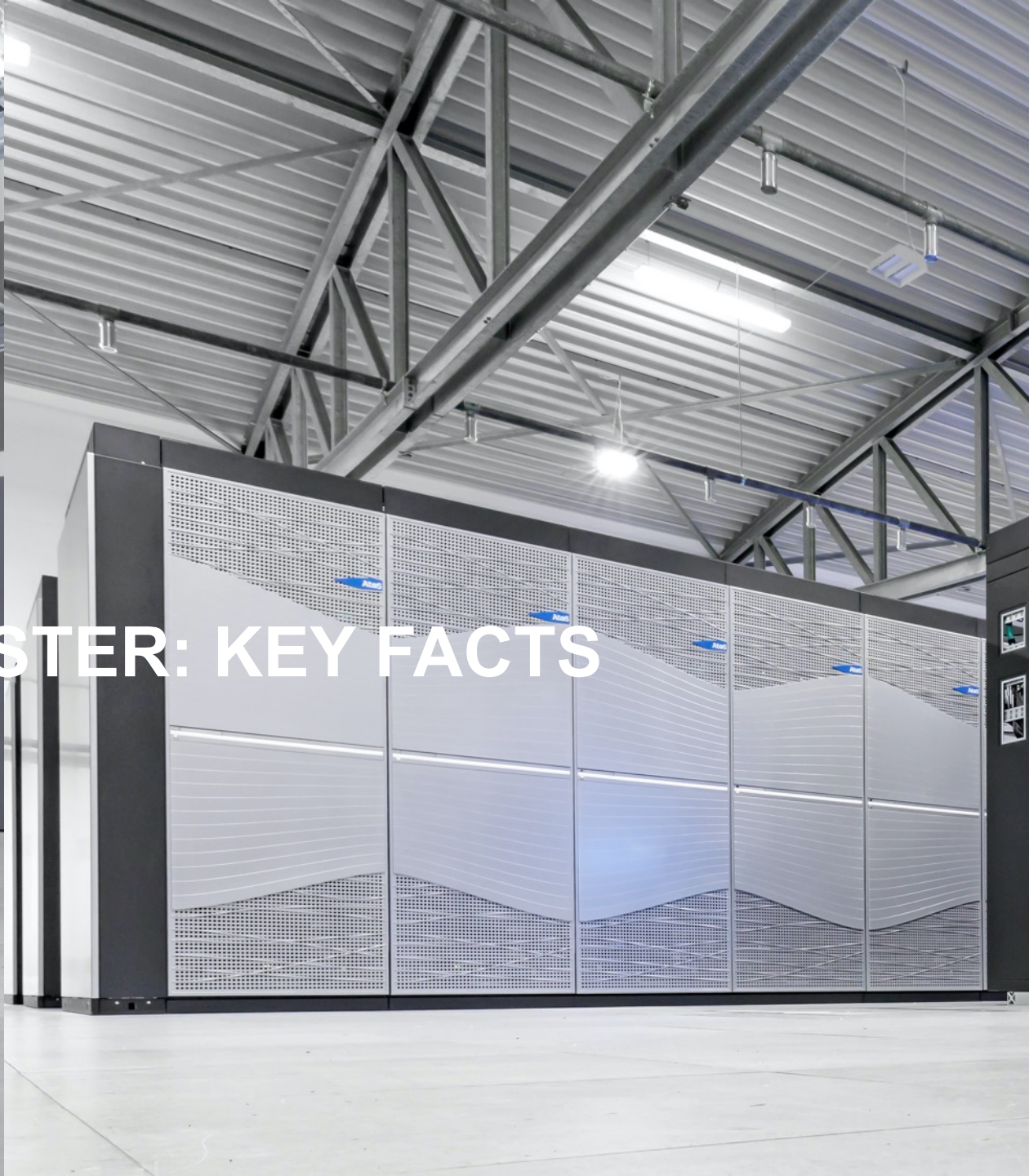
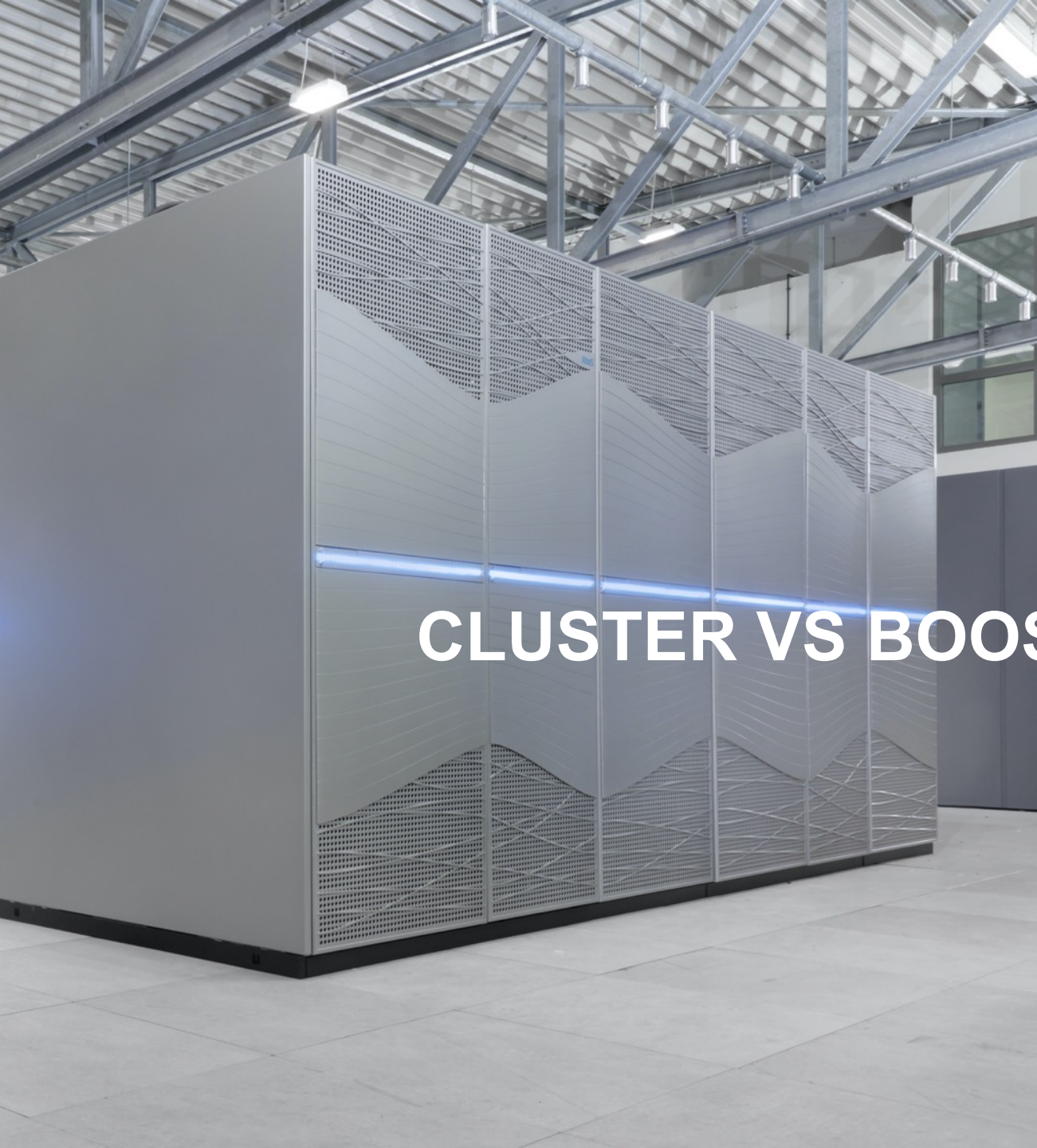

CLUSTER VS BOOSTER: KEY FACTS

CLUSTER VS BOOSTER –NODE VIEW– (1/2)

JUWELS Cluster (w/o GPU nodes)

JUWELS Booster

Processors	Intel	-	AMD	Processors
Cores	48	x1	48	Cores
Vector width (CPU)	512	x0.5	256	Vector width (CPU)
Memory (main)	96/192 GB	x5.33/2.66	512 GB	Memory (main)
Memory BW (main)	256 GB/s	x1.59	408 GB/s	Memory BW (main)
GPUs	0	xNaN	4	GPUs
Memory (GPU)	0	xNaN	160 GB	Memory (GPU)
Memory BW (GPU)	0	xNaN	6 TB/s	Memory BW (GPU)
HCA	1	x4	4	HCA
Link BW	100 Gbps	x2	200 Gbps	Link BW
Network BW	100 Gbps	x8	800 Gbps	Network BW
TFLOPs	4.15	x18.8	78	TFLOPs (GPUs)

CLUSTER VS BOOSTER –GLOBAL VIEW– (2/2)

JUWELS Cluster (w/o GPU nodes)

Peak performance	10.6 PF
Concurrency	240 K
Total memory	96 TB
Total memory BW	0.6 PB/s
Gb per TF	24.1
Injection BW	251 Tb/s
Topology	Prun. FT
Global network bandwidth	63 Tb/s
Routing	Detem.

x6.88

x216

x6.5

x9.3

x0.42

x2.98

-

x3.17

-

JUWELS Booster

73 PF

»52 M

629 TB

5.6 PB/s

10.3

749 Tb/s

DF+

200 Tb/s

Adaptive

Peak performance

Concurrency

Total memory

Total memory BW

Gb per TF

Injection BW

Topology

Global network bandwidth

Routing

JUWELS CLUSTER LOGIN NODES

- 9 + 2 standard login nodes
 - 2× 20-core Intel Xeon Gold 6148
 - 756 GB DDR4 @ 2.666 GHz
 - 100 GigE external network
- 4 visualization nodes
 - 2× 20-core Intel Xeon Gold 6148
 - 756 GB DDR4 @ 2.666 GHz
 - 100 GigE external network
 - 1x Nvidia P100 GPU
 - Different compute capabilities than in compute nodes!
- Used for:
 - Compile/submit jobs
 - Small pre- and post-processing/visualization
 - Shared nodes!



JUWELS BOOSTER LOGIN NODES

- 4 login nodes
 - 2× 24-core AMD Epyc 7402 Rome CPUs
 - 512 GB DDR4 @ 3.2 GHz
 - 100 GigE external network
 - **No GPUs!**
- Used for:
 - Compile/submit jobs
 - **Small** pre- and post-processing/visualization
 - **Shared nodes!**



JURECA-DC

DC = Data Centric

- Intended for mixed capacity and capability workloads
- Designed with big-data science needs in mind





JURECA-DC

DC = Data Centric







JURECA-DC CPU NODES

- 576 compute nodes **Atos**
 - 2x **64-core** AMD Epyc 7742 Rome CPUs **AMD**
 - 2x 8 memory channels
 - 2x 256 GB DDR4 @ 3.2 GHz
 - 96 nodes with 2x 512 GB DDR4 @ 3.2 GHz
 - 2x 4 NUMA domains
 - PCIe Gen4
 - 1x HDR100 InfiniBand adapter (100Gbps) 



JURECA-DC GPU NODES

- 192 compute nodes 
 - 2x **64-core** AMD Epyc 7742 Rome CPUs 
 - 2x 8 memory channels
 - 2x 256 GB DDR4 @ 3.2GHz
 - 96 PCIe Gen4 lanes
 - 512 GB DDR memory
 - **4x** Nvidia A100 GPUs 
 - 9.7 / 19.5 TF/s peak
 - 40 GB HBM2
 - 1.5 TB/s memory performance
 - NVLink3 full mesh
 - 4 links (200GB/s) between GPU pairs
 - PCIe Gen4 x32 (64 GB/s)
 - **2x** HDR200 InfiniBand adapter (1 per GPU) 
 - **On SW appears as 4 adapters**



JURECA-DC LOGIN NODES

- 12 login nodes
 - 2× 64-core AMD Epyc 7742 Rome CPUs
 - 1024 GB DDR4 @ 3.2 GHz
 - 100 GigE external network
 - 2x Nvidia RTX8000 GPUs
 - Different compute capabilities than in compute nodes!
- Used for:
 - Compile/submit jobs
 - Small pre- and post-processing/visualization
- Shared nodes!





JUSUF

- Serves the ICEI project (Interactive Computing E-Infrastructure for the Human Brain Project)
- Contains 2 partitions
 - HPC
 - Cloud
- Air-cooled, less dense than other systems





JUSUF HPC PARTITION

- 124 compute nodes **Atos**
 - 2x **64-core** AMD Epyc 7742 Rome CPUs **AMD**
 - 2x 8 memory channels
 - 2x 128 GB DDR4 @ 3.2 GHz
 - 2x 4 NUMA domains
 - PCIe Gen4
 - 1x HDR100 InfiniBand adapter (100Gbps)
 - 1x 40 GbE adapter (for storage)
 - **1TB NVMe local scratch**
- 49 GPU nodes **Atos**
 - Same config as CPU nodes. Additionally:
 - 1x Nvidia V100 GPUs 
 - 7.8 TF/s peak
 - 16 GB HBM2
 - 900 GB/s memory performance
 - PCIe Gen3 x16 (32 GB/s bidir)



JUSUF CLOUD PARTITION

- 4 compute nodes **Atos**
 - 2× **64-core** AMD Epyc 7742 Rome CPUs **AMD**
 - 2x 8 memory channels
 - 2x 128 GB DDR4 @ 3.2 GHz
 - 2x 4 NUMA domains
 - PCIe Gen4
 - 1x HDR100 InfiniBand adapter (100Gbps)
 - 1x 40 GbE adapter (for storage)
 - **1TB NVMe local scratch**
- 12 GPU nodes **Atos**
 - Same config as CPU nodes. Additionally:
 - 1× Nvidia V100 GPUs 
 - 7.8 TF/s peak
 - 16 GB HBM2
 - 900 GB/s memory performance
 - PCIe Gen3 x16 (32 GB/s bidir)





FURTHER INFORMATION

MAINTENANCE HANDLING

- JSC systems go on maintenance for any of the following reasons:
 - JUST (storage cluster) needs maintenance
 - Compute node updates (OS and/or FW and/or configuration changes)
 - Admin node updates (OS and/or FW and/or configuration changes)
 - Emergencies
- Frequency
 - Depends on pending issues
 - Typically decreases as system ages
- Days and duration
 - Typically on Tuesdays
 - Whole working day
 - Announced with at least 1 week in advance
- Communicated through **MOTD** and **status page**

IMPORTANT LINKS

- Status page:
 - <https://status.jsc.fz-juelich.de/>
- General system information
 - <https://go.fzj.de/JUWELS>
 - <https://go.fzj.de/juwels-known-issues>
 - <https://go.fzj.de/JURECA>
 - <https://go.fzj.de/jureca-known-issues>
 - <https://go.fzj.de/JUSUF>
 - <https://go.fzj.de/jusuf-known-issues>
- User documentation:
 - <https://apps.fz-juelich.de/jsc/hps/juwels/index.html>
 - <https://apps.fz-juelich.de/jsc/hps/jureca/index.html>
 - <https://apps.fz-juelich.de/jsc/hps/jusuf/index.html>
- Job reporting:
 - <https://go.fzj.de/llview-juwels>
 - <https://go.fzj.de/llview-juwelsbooster>
 - <https://go.fzj.de/llview-jureca>
- User support at FZJ
 - sc@fz-juelich.de
 - Phone: 02461 61-2828

THANK YOU